

Campus Map



P (bell salle Takadanobaba)

B1F: Poster Session
JSAP EXPO Spring

**bell salle
Takadanobaba**

Shinjuku
Garden Tower

G (63 Bldg.)

2F G201~G205
1F Cafeteria

West Gate

Toyama Park

F (61 Bldg.)

3F: F306, F310, F314
2F: F202, F206, F210, F214
1F: F102, F104

C (52 Bldg.)

3F: C301~C304
2F: C201~C204
1F: C101~C104

**Waseda Univ.
Nishi-waseda Campus**

E (57 Bldg.)

2F: E201, E202

B (53 Bldg.)

4F: B401, B403
3F: B301, B303
2F: B201~B204
1F: B101~B104

**51
Bldg.**

D (56 Bldg.)

1F: D101~D104
B1F: Cafeteria, Shop

Nishi-waseda Station
Exit #3

A (54 Bldg.)

4F: A401~A404
3F: A301~A304
2F: A201~A204
1F: A101~A104, VIP Room

**F
11**

Registration

Meiji Gate

Meiji Street

Registration · Secretariat Office · Cloak (55 Bldg. 1F)

Registration

3/17(Sat.)-19(Mon.) 8:30-17:30
3/20(Tue.) 8:30-13:00

Cloak

3/17(Sat.)-19(Mon.) 8:30-20:00
3/20(Tue.) 8:30-18:00

Floor Plan (A, B, C)



A (54 Bldg.)

B (53 Bldg.)

C (52 Bldg.)

1F

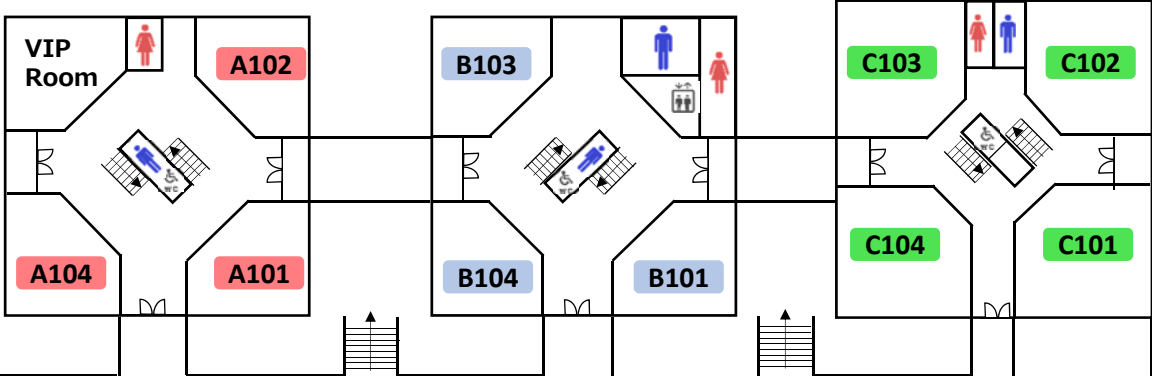

Inner courtyard

2F

55 Bldg. 2F

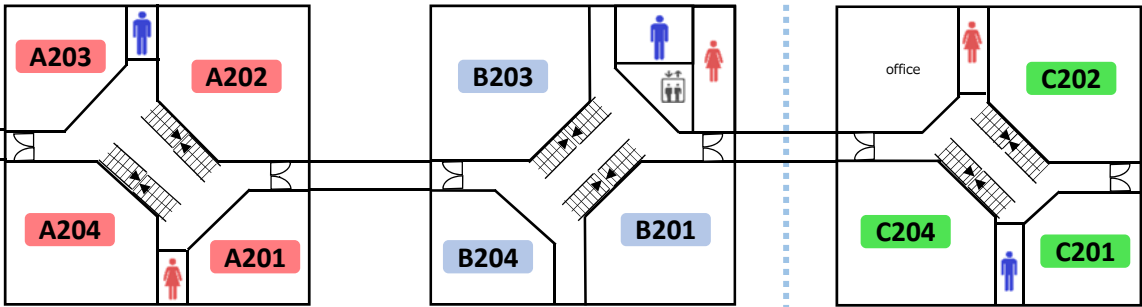

3F

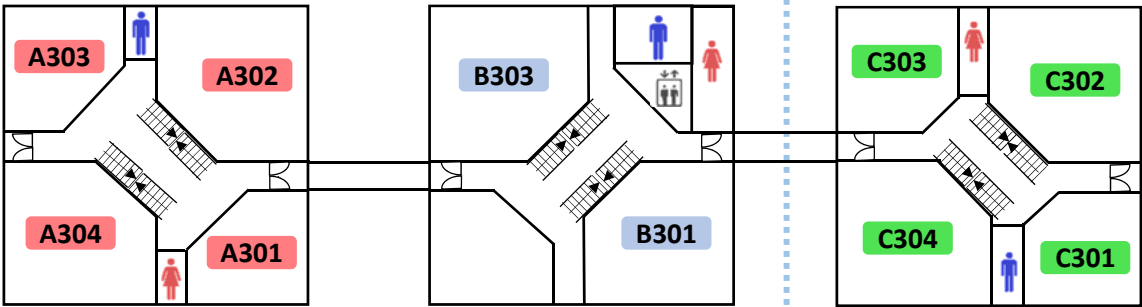

4F

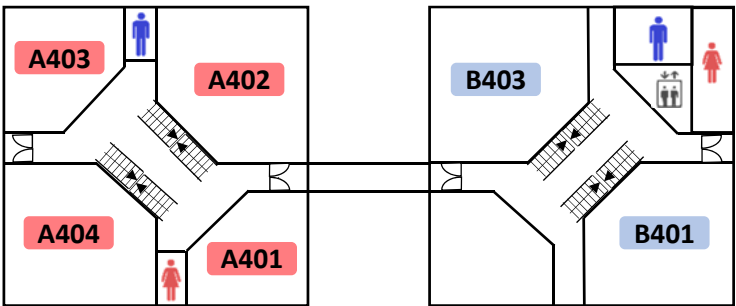

Floor Plan (D, E)

E (57 Bldg.)

2F

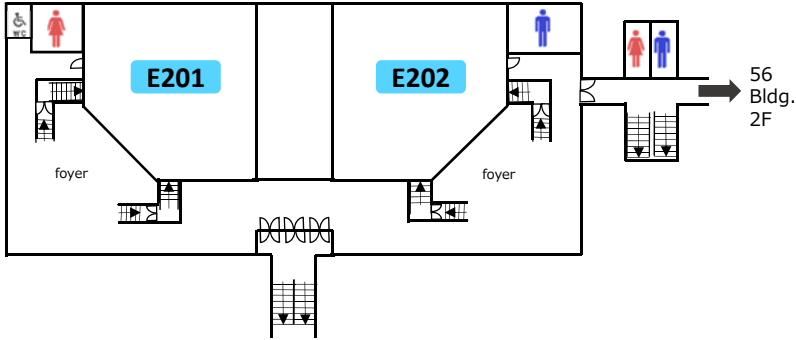

D (56 Bldg.)

1F

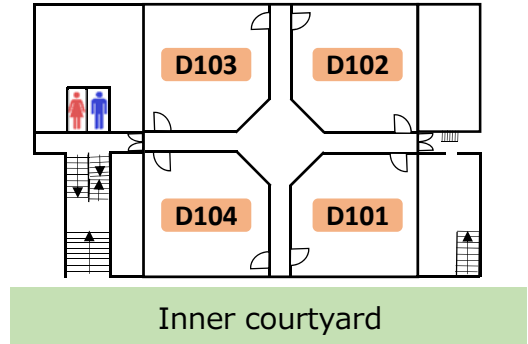

F (61 Bldg.)

1F

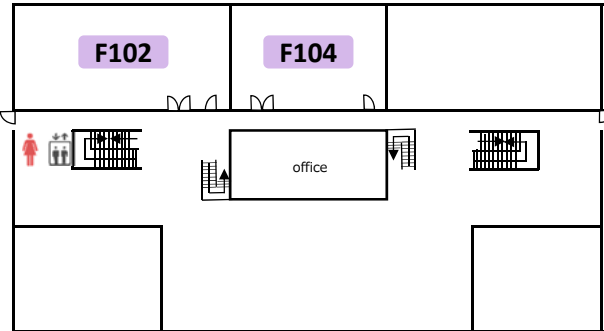

2F

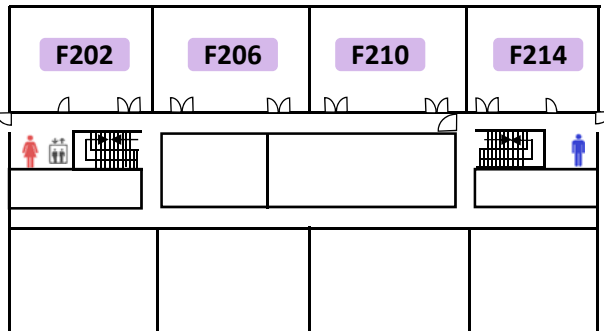

3F

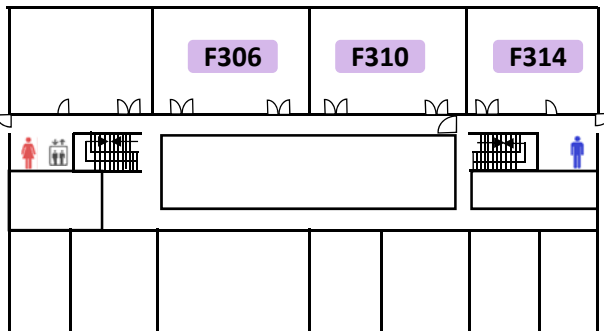

Floor Plan (G, P)

G (63 Bldg.)

2F

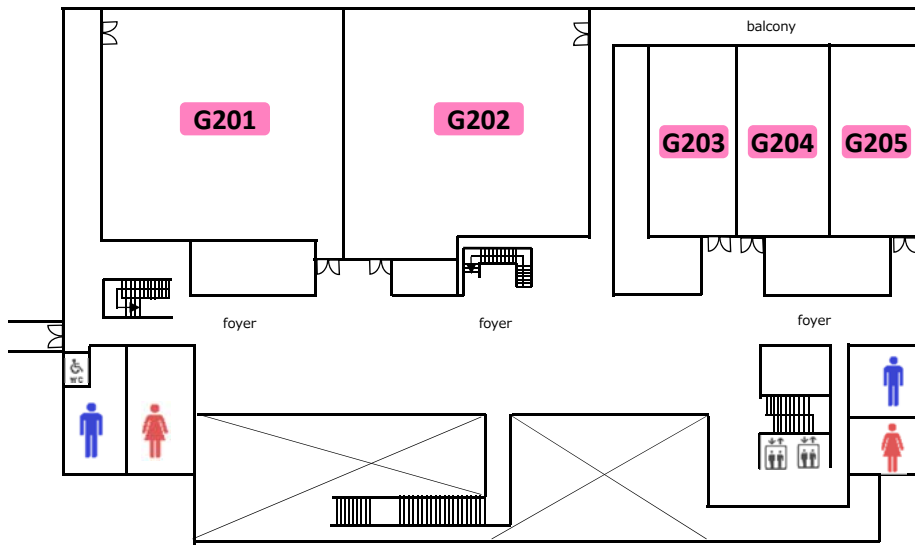

P (bell salle Takadanobaba)

B2F

